



THE UNIVERSITY OF ARIZONA

Mel & Enid Zuckerman
College of Public Health



UNIVERSITY OF MIAMI
MILLER SCHOOL
of MEDICINE



SCHOOL OF PUBLIC HEALTH

ENVIRONMENTAL HEALTH SCIENCES

UNIVERSITY OF MICHIGAN

PFAS Exposure and Epigenetics in the Fire Fighter Cancer Cohort Study

JEFF BURGESS, MD, MS, MPH

UNIVERSITY OF ARIZONA

JACKIE GOODRICH, PHD

UNIVERSITY OF MICHIGAN

Overview

- Unique health risks from firefighting
- The Fire Fighter Cancer Cohort Study (FFCCS)
- PFAS exposure and Epigenetic Biomarkers in the FFCCS

Exposure Burden of Firefighters

- Exposures to multiple hazards
 - Heat
 - Stress
 - Flame-retardant chemicals (PFAS in AFFF)
 - Smoke/ polycyclic aromatic hydrocarbons
 - Other chemicals released from burning structures
 - Shiftwork
- Exposures vary by job/tasks
 - Structural
 - Aircraft rescue & firefighting
 - Wildland-urban interface
 - Trainers
 - Investigators



FFCCS Research Concepts

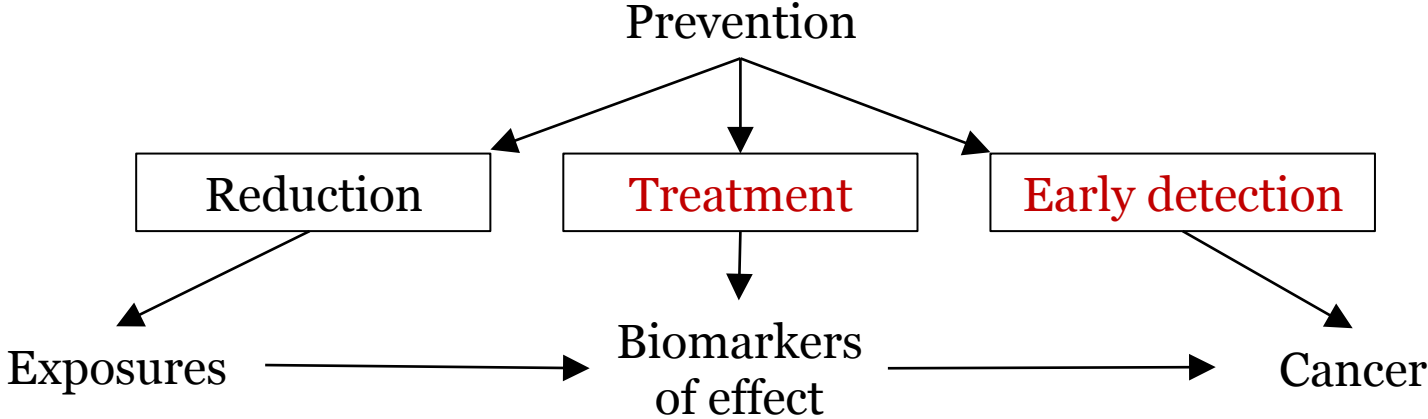

Smoke (PAHs)
 PFAS
 BFRs/OPFRs
 Stress
 Diet
 Physical activity
 Other lifestyle
 COVID-19
Shiftwork
RF exposures

DNA methylation
 microRNA
 Metabolomics
 Anti-Müllerian hormone (AMH)
 DNA mutations
DNA adducts
Sperm changes
Neutraceutical Rx

Support for presumptive laws
Cell-free DNA
Improved imaging

New recruits & incumbent firefighters

Subgroups
 Women
 Volunteer
 Trainer
 Investigator

WUI
 Airport
 Wildland
Under-represented

Other outcomes
 Reproductive (women)
Reproductive (men)

(Potential future research topics in red font)

Per- and Polyfluoroalkyl Substances (PFAS)

- 9000 of these chemicals exist including legacy and replacement versions
- In drinking water of >100 million Americans
- Toxic; linked to risks for some cancers
- Occupational exposure is an issue for firefighters
 - AFFF
 - Gear
 - Released from burning structures



FFCCS and PFAS research

1. > 200 structural firefighters



2. 100 incumbent and 50 new recruit firefighters

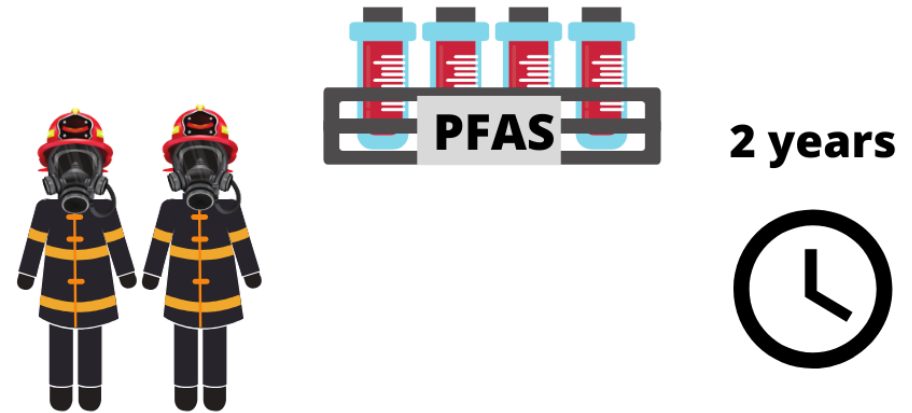

3. ~200 ARFF firefighters



4. *In vitro* and chronic human toxicity

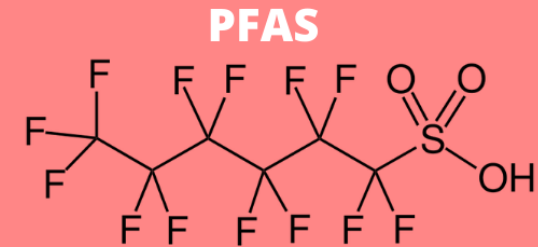
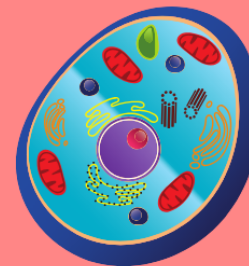

(https://commons.wikimedia.org/wiki/File:Perfluorohexanesulfonic_Acid_Structural_Formula_V1.svg)

Epigenetic changes

Serum PFAS in municipal firefighters & NHANES

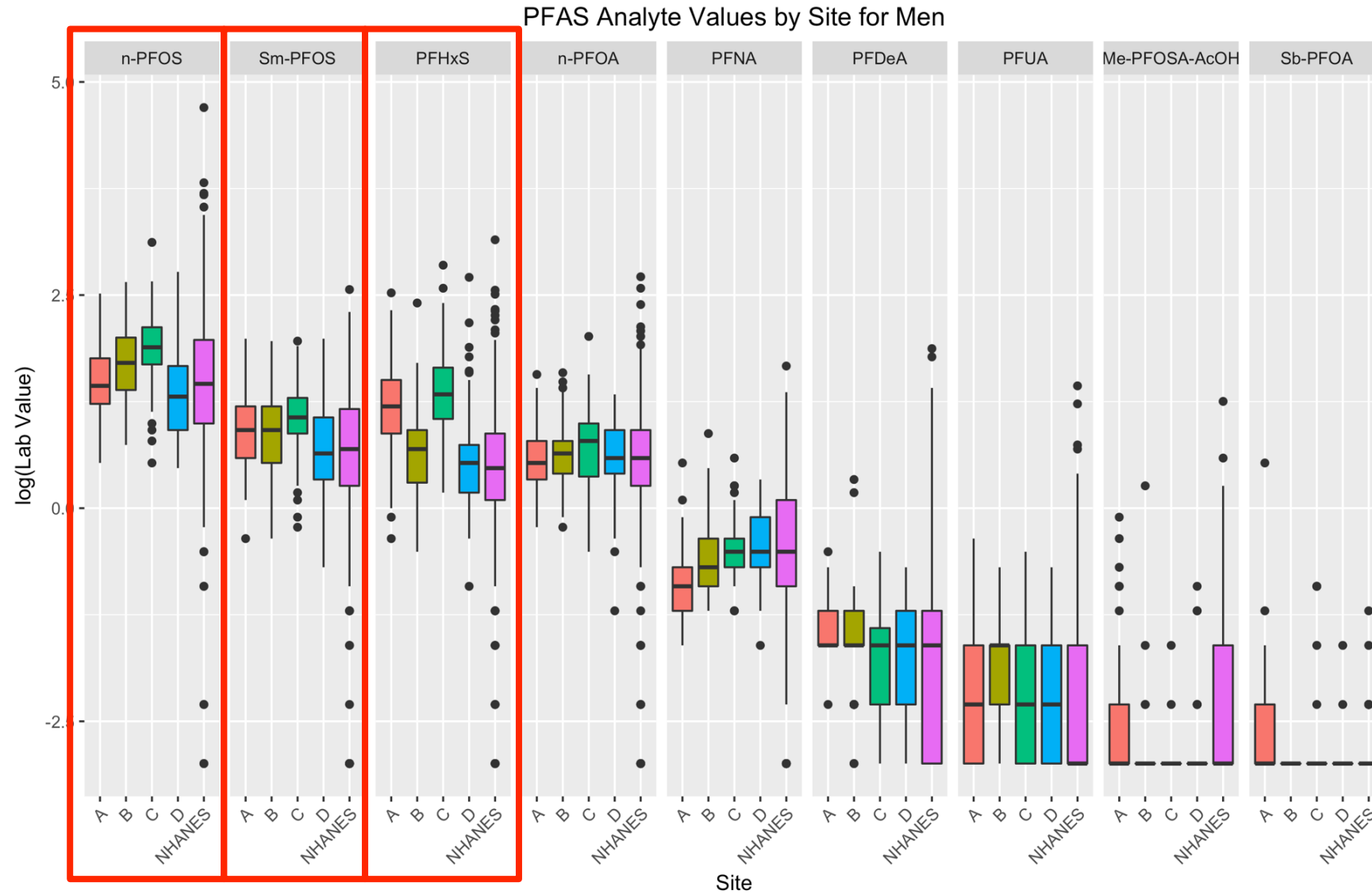

Serum PFAS in airport firefighters & NHANES

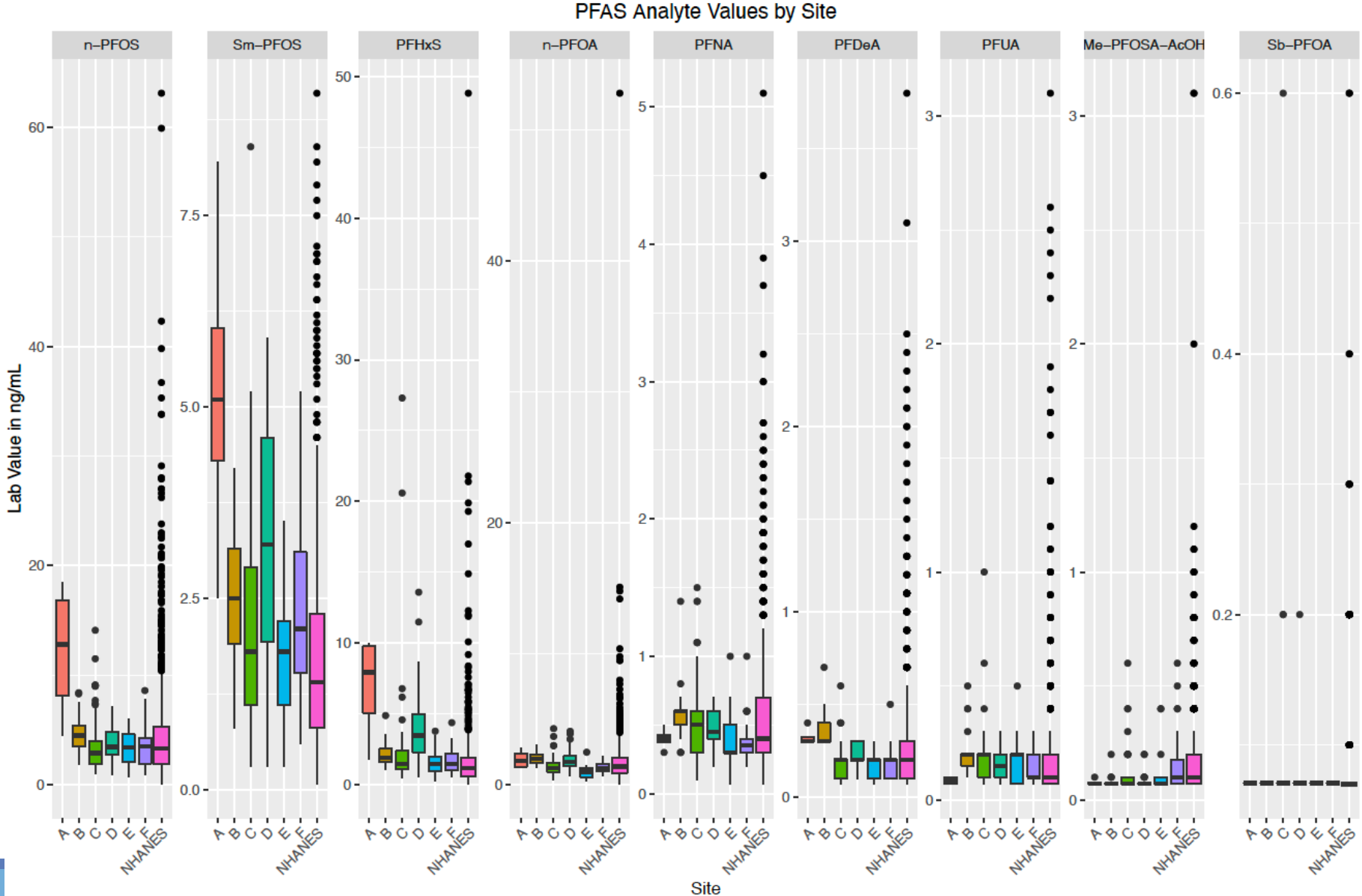

Individual serum PFAS results – EXAMPLE*

- ◆ The amount measured in your serum in micrograms per liter (ug/L)
- The average amount measured in study participants from your fire department
- ▲ The 50th percentile for the US population (the middle amount among those sampled)*
- The 95th percentile for the US population (95% of people have an amount below this value)*
- The range of amounts measured in all study participants from your fire department

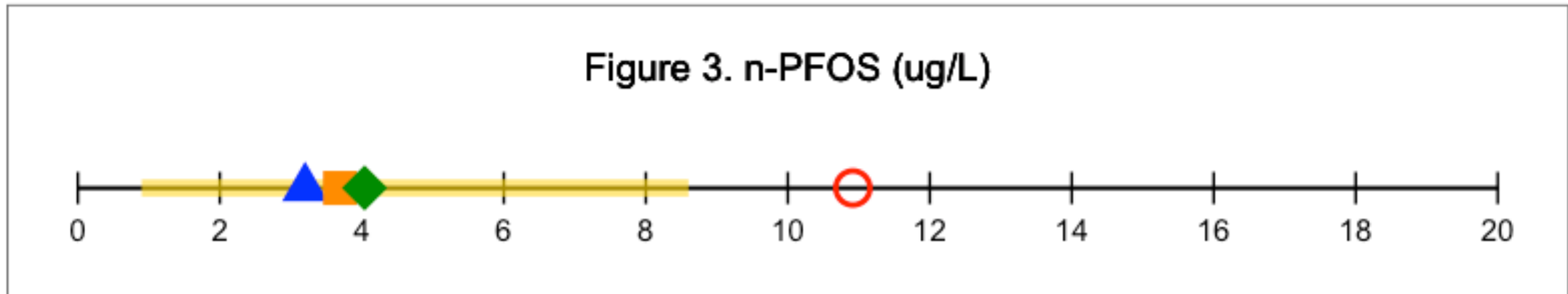

*Values here are randomly generated

Examining Biomarkers of Toxicity to PFAS

What are biomarkers and why do we use them?

Biomarker: a chemical or the product of a chemical reacting with a cellular component that is measured in the human body.

(Environmental Health Criteria 237. WHO, 2006)

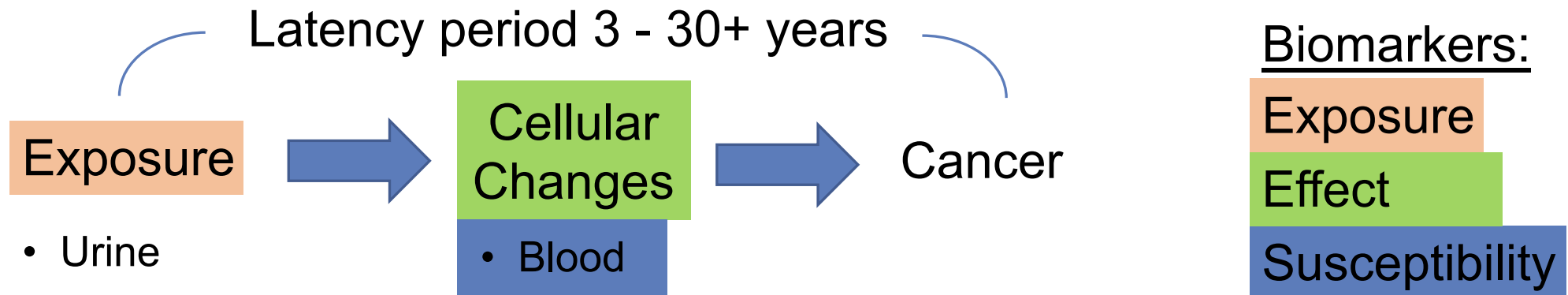

Epigenetic Biomarkers

- ‘On top of’ the genome
- Changes in gene function/expression that occur without a change in the sequence of nuclear DNA.
- Types of epigenetic regulation:
 - **DNA methylation**
 - Post-translational histone tail modifications
 - Chromatin accessibility
 - Non-coding RNAs

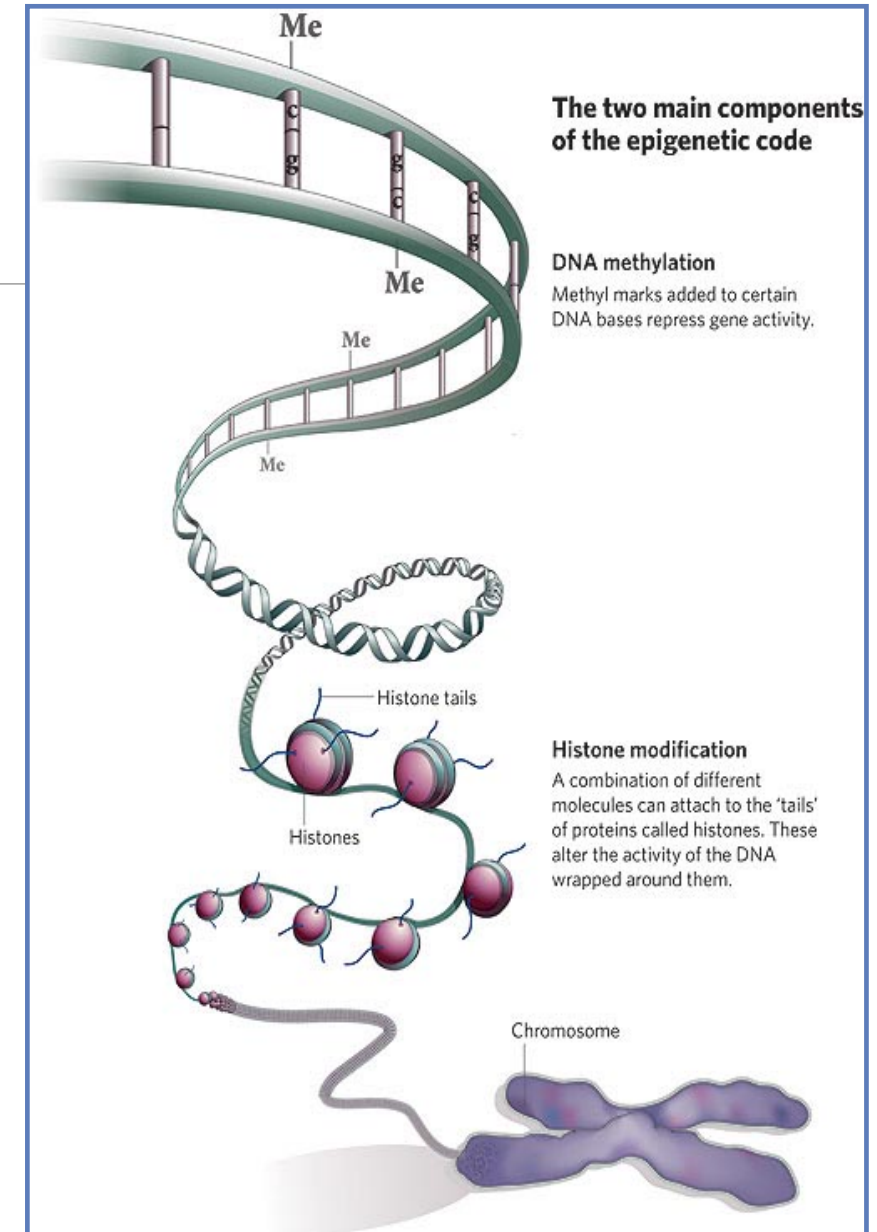

Epigenetics Metaphor

Genetics



Epigenetics



DNA Methylation

typically **interferes**
with transcription

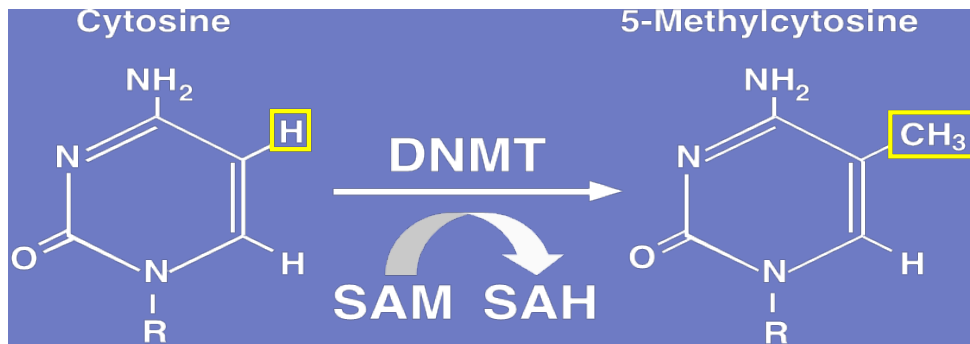

DNMT: DNA methyltransferase
SAM: S-adenosyl-methionine
SAH: S-adenosyl-L-homocysteine

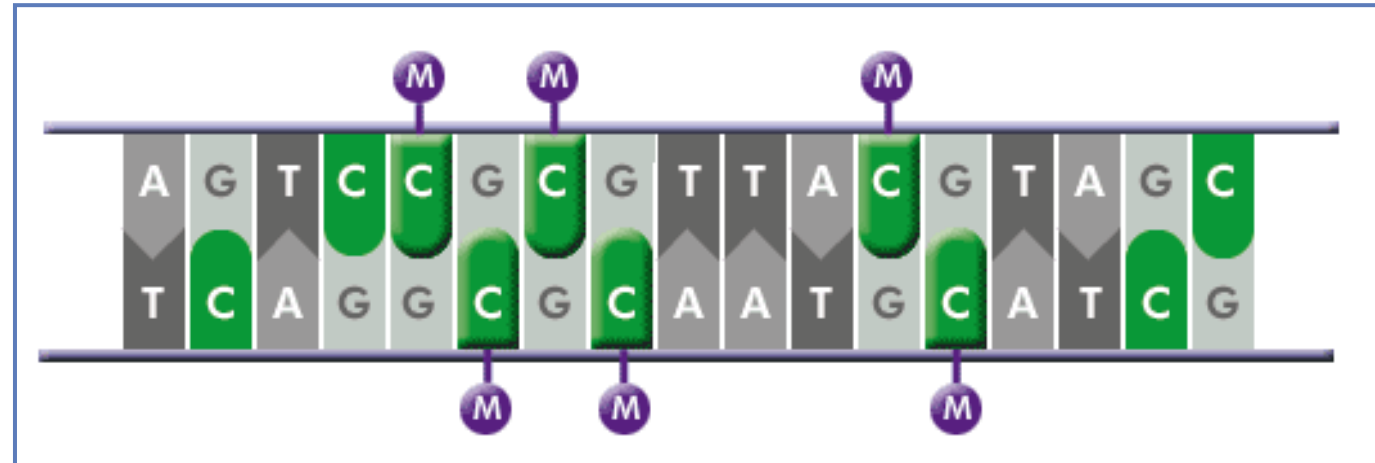

occurs at “CpG sites”

Why measure epigenetic biomarkers in firefighters?

Firefighters have increased risk for some cancers.

Occupational exposures, including to chemicals [**PFAS**], sleep disruptions, heat, stress, and more could contribute to this risk.

Exposures Impact Epigenetics

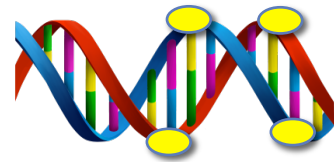

Exposures Impact Epigenetics

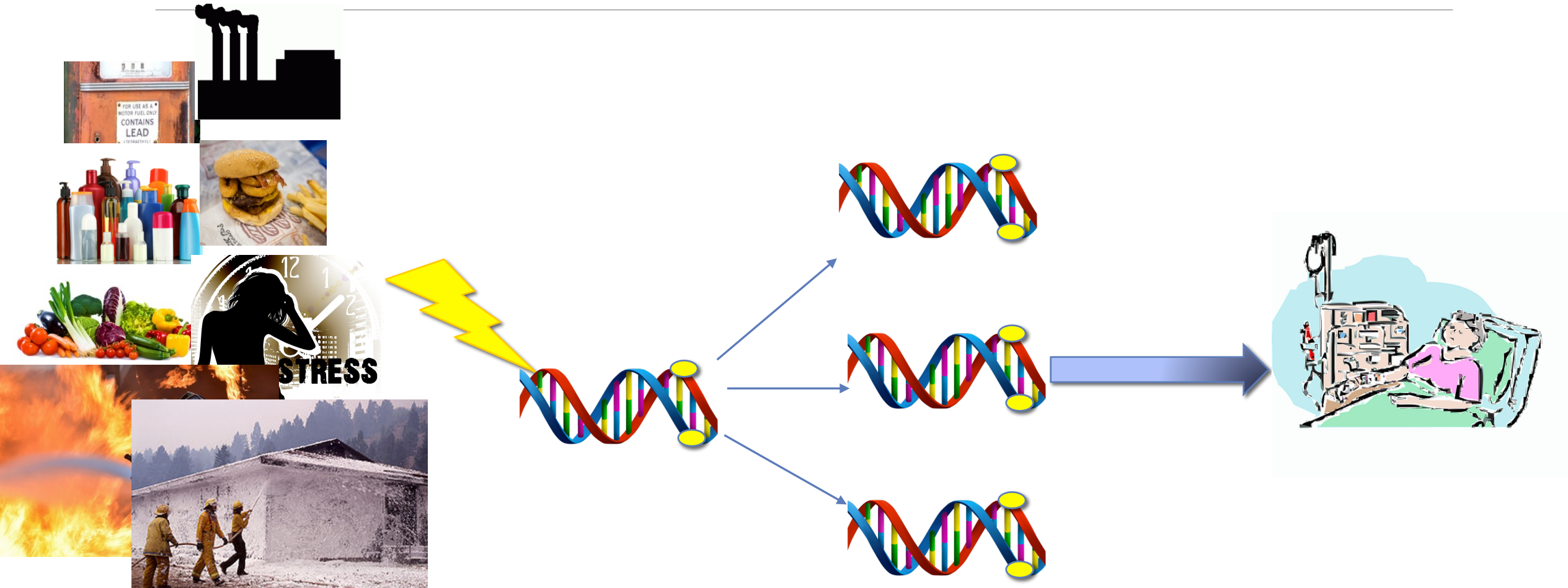

Why measure epigenetic biomarkers in firefighters?

Firefighters have increased risk for some cancers.

Occupational exposures could contribute to this risk.

The epigenome changes in response to the environment.

Why measure epigenetic biomarkers in firefighters?

Firefighters have increased risk for some cancers.

Occupational exposures could contribute to this risk.

The epigenome changes in response to the environment.

Widespread epigenetic changes are part of the process that leads to cancer.

The epigenome can change before disease occurs and could serve as a biomarker to predict future disease.

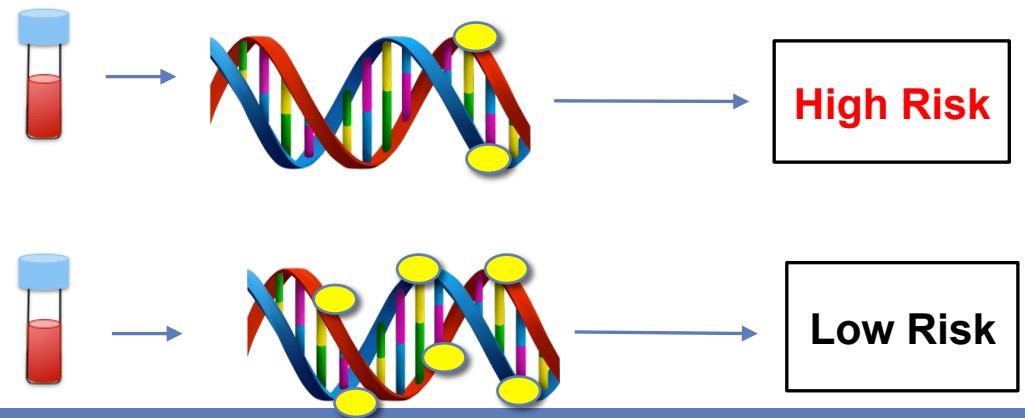

PFAS and Epigenetics in Firefighters: Research Question #1

Do exposures to PFAS accelerate epigenetic age?

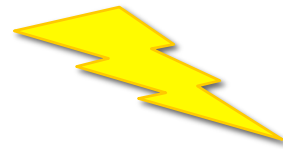

Methods: DNA Methylation Analysis

- Isolate DNA from blood leukocytes
- Illumina Infinium MethylationEPIC
- Quantifies DNA methylation at >850,000 CpG sites (in all genes)
- Calculate epigenetic clocks
- Statistics to model relationship between each PFAS and epigenetic clocks or DNA methylation at each CpG site

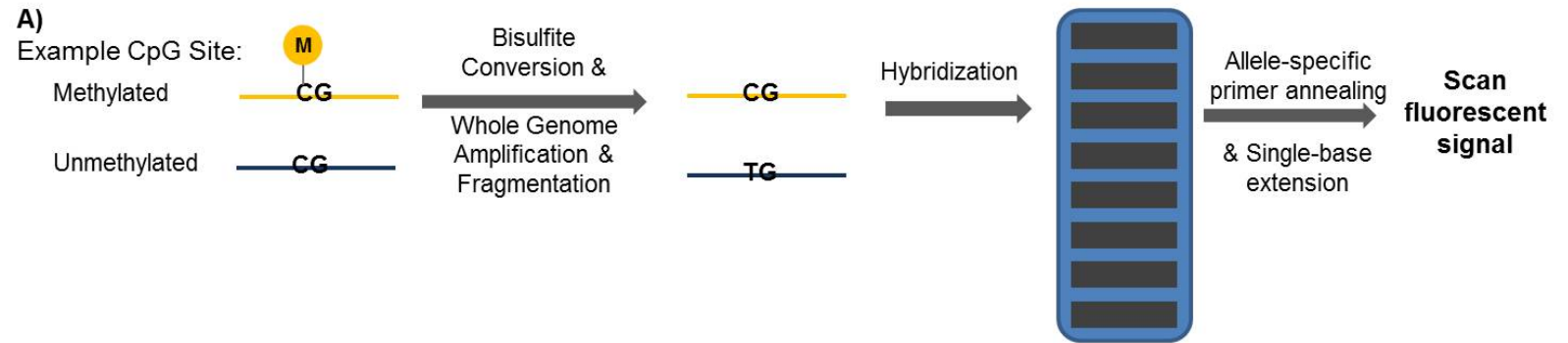

B) Type I Probe (Unmethylated Locus):

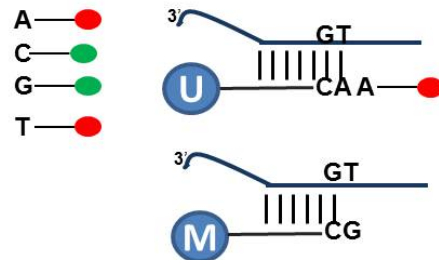

C) Type II Probe (Unmethylated Locus):

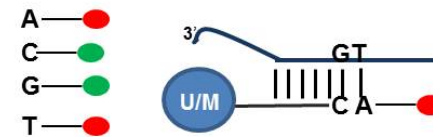

Epigenetic Age: A Biomarker of Biological Age

DNA methylation at certain regions is predictive of age

Several 'epigenetic clocks' have been developed from DNA methylation data that approximate biological aging

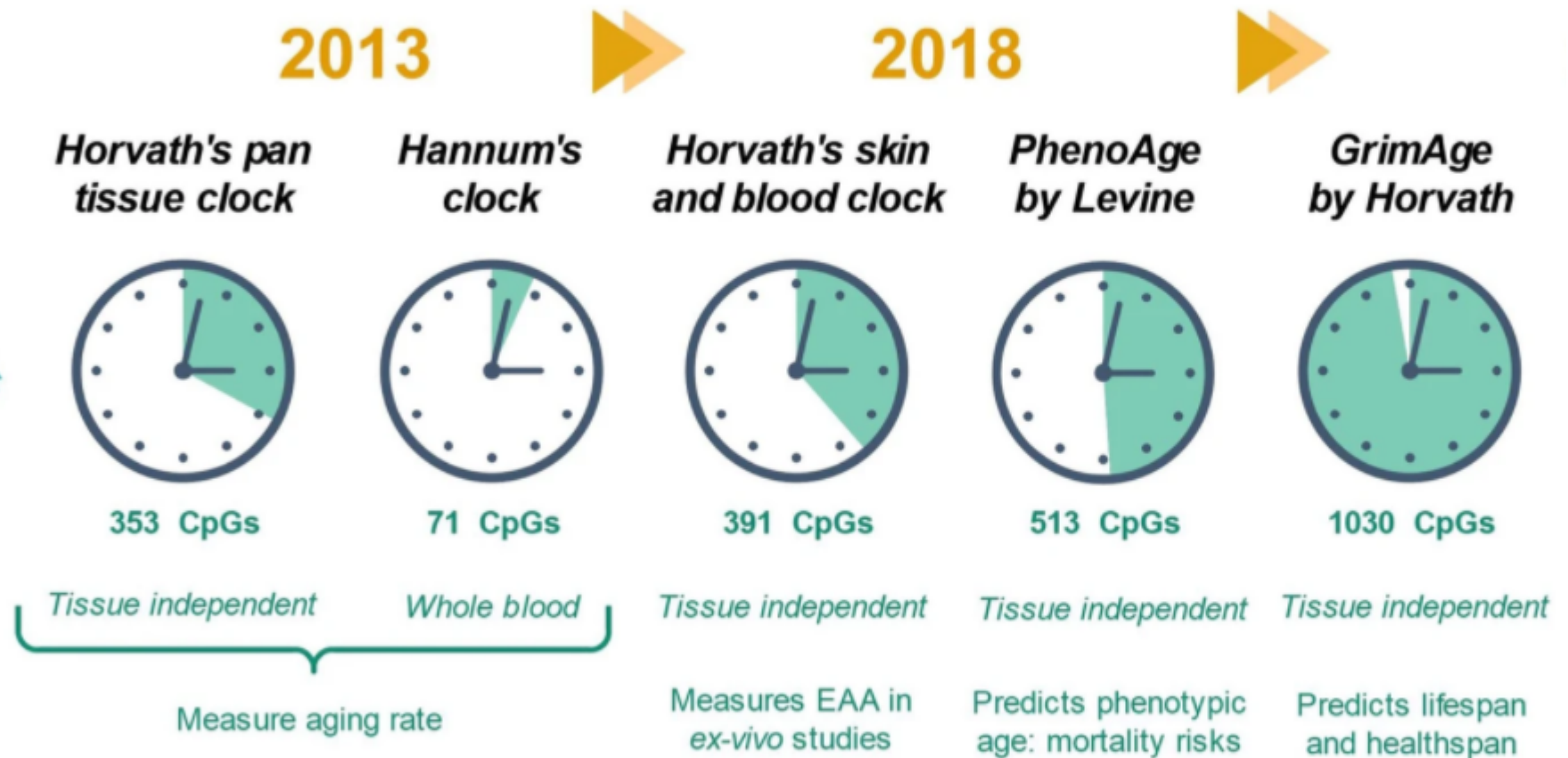

Epigenetic Age, Disease, & Mortality

Accelerated epigenetic age correlates with worse health outcomes

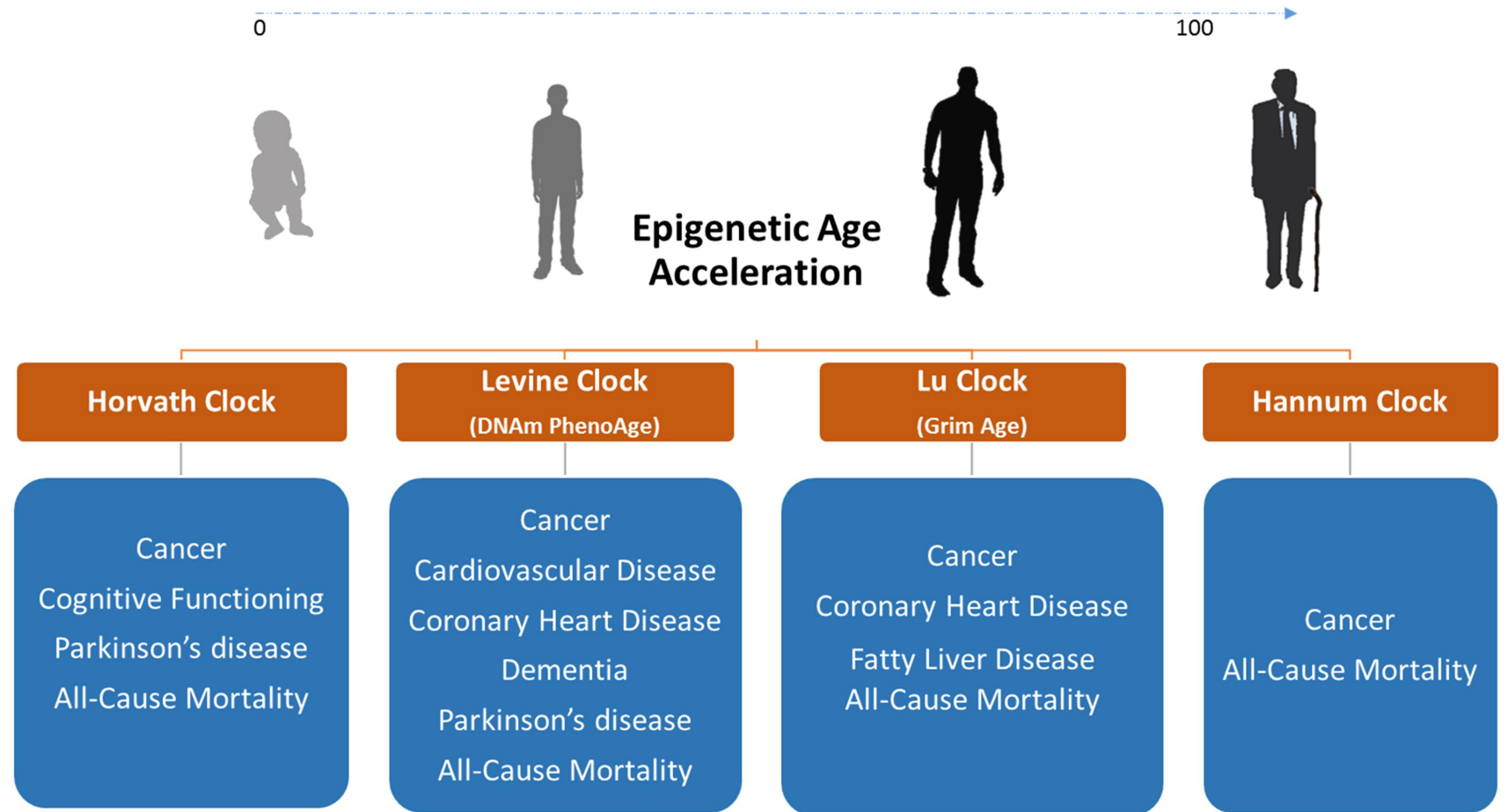

Study Population

	N	%
Male	176	89.3
Female	21	10.7
Hispanic	30	15.2
Non-Hispanic	167	84.8
Caucasian Race	188	95.4
All Other Races	9	4.6
	Mean (SD)	
Age (years)	38.6 (9.7)	
BMI (kg/m ²)	26.94 (3.35)	

197 active structural firefighters with PFAS exposure analysis and DNA methylation analysis completed.

From 3 Depts.

Results: Serum PFAS Concentrations

Abbreviation	Full Name	% Above LOD	Geometric Mean	95% CI
PFHxS	perfluorohexane sulfonate	100	2.50	(2.29, 2.74)
n-PFOA	linear perfluorooctanoate	100	1.79	(1.68, 1.89)
Sb-PFOA	sum of branched isomers of perfluorooctanoate	31.0	<LOD	<LOD
n-PFOS	linear perfluorooctane sulfonate	100	4.02	(3.74, 4.32)
Sm-PFOS	sum of perfluoromethylheptane sulfonate isomers	100	2.06	(1.91, 2.23)
PFNA	perfluorononanoate	98.5	0.44	(0.41, 0.48)
PFDeA	perfluorodecanoate	99.0	0.23	(0.22, 0.25)
PFUA	perfluoroundecanoate	66.0	0.12	(0.11, 0.13)
MeFOSAA	2-(N-methyl-perfluorooctane sulfonamido) acetate	27.9	<LOD	<LOD

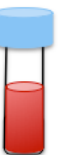

Results: Some PFAS chemicals were linked to accelerated epigenetic age (in blue)

PFAS	IEAA	EEAA	Horvath	Hannum	PhenoAge	SkinBlood Clock	GrimAge
PFHxS	0.77 (0.5)	1.05 (0.44)	0.93 (0.5)	0.97 (0.4)	0.58 (0.57)	1.13 (0.4)	0.49 (0.27)
n-PFOA	2.12 (0.71)	1.57 (0.63)	2.28 (0.71)	1.45 (0.58)	1.62 (0.82)	1.71 (0.58)	0.16 (0.39)
Sb-PFOA	0.63 (0.69)	0.09 (0.60)	0.70 (0.69)	0.08 (0.56)	0.23 (0.78)	0.49 (0.55)	-0.3 (0.36)
n-PFOS	0.8 (0.68)	0.83 (0.6)	1.04 (0.68)	0.77 (0.55)	-0.36 (0.77)	0.46 (0.55)	0.65 (0.36)
Sm-PFOS	1.69 (0.65)	0.97 (0.57)	1.85 (0.64)	0.89 (0.53)	-0.18 (0.74)	0.88 (0.53)	0.6 (0.34)
PFNA	0.03 (0.64)	-0.11 (0.56)	0.09 (0.64)	-0.1 (0.52)	-0.73 (0.72)	-0.34 (0.51)	-0.18 (0.34)
PFDeA	-0.63 (0.7)	-0.18 (0.61)	-0.43 (0.7)	-0.16 (0.57)	-0.6 (0.79)	-0.71 (0.56)	-0.91 (0.36)
PFUA	0.09 (0.62)	-0.72 (0.54)	0.03 (0.62)	-0.67 (0.5)	-0.47 (0.7)	-0.57 (0.5)	-0.76 (0.33)
MEFOSAA	0.45 (0.67)	-0.87 (0.59)	0.47 (0.67)	-0.81 (0.54)	-0.69 (0.76)	-0.27 (0.54)	0.32 (0.36)

Color Key
+ association, p<0.05
+ association, p>0.05
- association, p>0.05
- association, p<0.05

P<0.05 in bold indicates significant relationship between the PFAS and the age estimator.

Goodrich et al., 2021, *Epigenomics*

PFAS and Epigenetics in Firefighters: Research Question #2

Are PFAS exposures associated with DNA methylation and at which genes? Are these genes in pathways relevant to cancer, immune function, or other disease states?

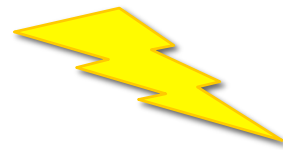

Analysis: DNA Methylation and PFAS

Discovery Approach – all CpG sites

- Single Site Analysis
- Regional Analysis
- Gene-set enrichment testing

Hypothesis-Driven Approach – 445 CpG sites from 32 genes

Epigenetic Age

For all of the above, assess associations with:

- 6 individual PFAS, continuous (PFDA, PFNA, PFHxS, n-PFOA, sm-PFOS, n-PFOS)
- 3 individual PFAS, detect vs. non-detect (MEFOSSA, PFUnDA, Sb-PFOA)

Results: PFAS and DNA Methylation

PFAS	Significant CpG Sites (p-value < $9e^{-8}$)	Significant Regions of Consecutive CpG Sites
PFHxS	0	0
n-PFOA	0	0
Sb-PFOA*	1 (↑ <i>CAPN12</i>)	1↓
n-PFOS	1 (↓ <i>RAD1</i>)	1↑
Sm-PFOS	0	0
PFNA	0	51↓ and 8 ↑
PFDeA	2 (↑ <i>TUBD1</i> and intergenic region)	2↑
PFUA*	1 (↑ <i>LOC339529</i>)	1↑
MEFOSAA*	0	0

Tested associations between PFAS concentrations and DNA methylation levels at >740,000 CpG sites (individually and in regions)

*Modeled as categorical (detect vs. not)

Results: PFAS chemicals were linked to altered DNA methylation at specific genes

- Genes involved in cancer processes:
 - snoRNAs, the oncogene *POU5F1*, and more (*CAPN12*, *RAD1*, *DDR1*, *RAB37*, *PASK*, *RGS7*, *RAPGEF1*, *MIPOL1*, *TNFAIP8L3*, *PCAT18*)
- Genes involved in immune function:
 - *IL32*, *SLFN12*, *CCL8*, and more

Results: Altered genes were enriched in many pathways

PFAS	Database	Enriched Gene Sets
n-PFOS	Gene Ontology (GO):	lipid export from cell, regulation of fatty acid oxidation, plasma membrane region, cell junction, hippo signaling, inorganic anion exchanger activity
	KEGG Pathways	inositol phosphate metabolism, morphine addiction
PFNA	Gene Ontology (GO):	cell leading edge, cell cortex, MHC class II protein complex
		movement of cell or subcellular component, regulation of locomotion, regulation of cellular component movement, regulation of ion transmembrane transport, cell motility, localization of cell, locomotion,
PFDeA	Gene Ontology (GO):	regulation of localization, regulation of transmembrane transport, positive regulation of receptor binding, inorganic cation transmembrane transport, voltage-gated cation channel activity, coronary vasculature development, regulation of cell migration, cation channel complex, biological adhesion, regulation of transporter activity, lamellipodium
	KEGG Pathways	Morphine addiction, Adrenergic signaling in cardiomyocytes, Circadian entrainment, GnRH secretion, cGMP-PKG signaling pathway

Conclusions

- Among structural firefighters we see evidence for a link between PFAS (PFHxS, n-PFOA, and Sm-PFOS) and accelerated epigenetic aging.
- We also observed evidence for altered methylation at specific genes by Sb-PFOA, n-PFOS, PFNA, PFDeA, and PFUA
- These associations do not prove causality. There may be other exposures from the occupation or the surrounding environment that are contributing to these associations.

Utility of Epigenetic Biomarkers

Research on exposures and epigenetics may inform:

- Risk assessment of potential hazardous substances
- Understanding of mechanisms of toxicity
- Development of prevention/intervention strategies to protect health

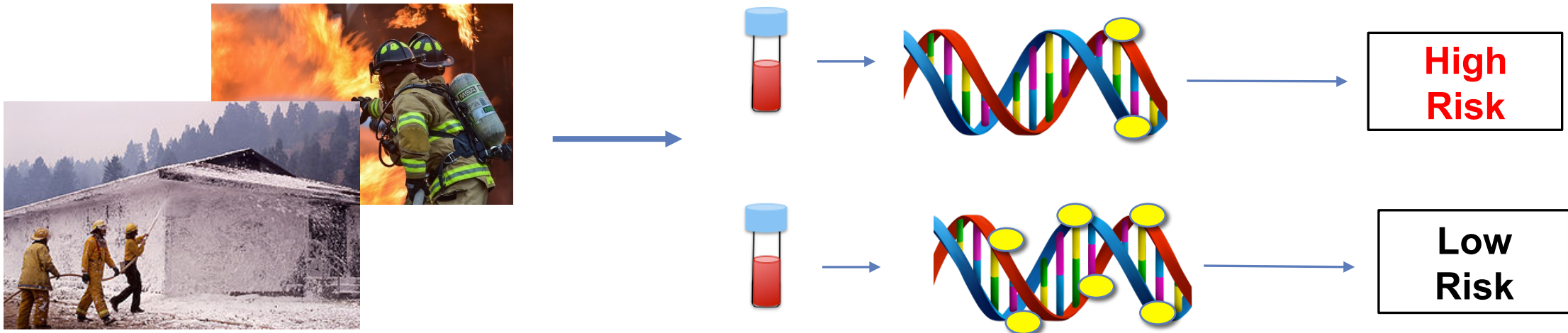

Long-View of the FFCCS

Identify the most harmful exposures to target for prevention/ reduction

Identify biomarkers that can warn of cancer risks early on

Inform intervention strategies to protect health



Acknowledgments

Funding Sources

NIEHS

P30 ES006694

P30 ES017885

FEMA

EMW-2014-FP-00200

EMW-2015-FP-00213

EMW-2018-FP-00086

NIOSH

Research Team

Univ. of Arizona

Jeff Burgess

Ken Batai

Shawn Beitel

Melissa Furlong

Alesia Jung

Sally Littau

Amy Nematollahi

NIOSH

Miriam Calkins

Todd Stueckle

CDC NCEH

Antonia Calafat

Julianne Botelho

Univ. of Miami

Alberto Caban-Martinez

Fire Service Partners

Casey Grant

John Gulotta

Darin Wallentine

Jeff Hughes

Charles Popp

Univ. of Michigan

Alisa Dewald

Rutgers Univ.

Judith Graber

Univ. of Rhode Island

Angela Slitt

Brigham Young Univ.

Timothy Jenkins



Questions?

Email us:

Jackie Goodrich, gaydojac@umich.edu

Jeff Burgess, jburgess@arizona.edu



THE UNIVERSITY OF ARIZONA

Mel & Enid Zuckerman
College of Public Health